















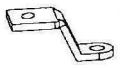

Držiak projektora na krátku projekciu

návod na montáž

Zoznam dielov

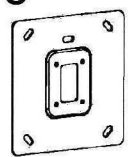
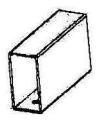
A  M8X60 (X5)	B  X1	C  S=5mm (X1)	D  PW6.2X13X1(X1)	E  M6X12 (X1)	F  M4X8 (X6)	G  M5X9 (X2)	H  M5X10 (X4)	I  S=3mm (X1)	J  X1
K  X2	L  M3X8 (X4)	M  PW3.2X10X1(X4)	N  S=2.5mm (X1)	O  X1	P  X1	Q  X1	R  X1	S  X1	

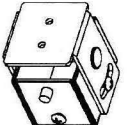
Inštalácia



Tento držiak na projektor na krátku projekciu sa smie inštalovať výlučne na tehlovom alebo betónovom múre a len s použitím výrobcom priložených skrutiek.

Upozornenie!

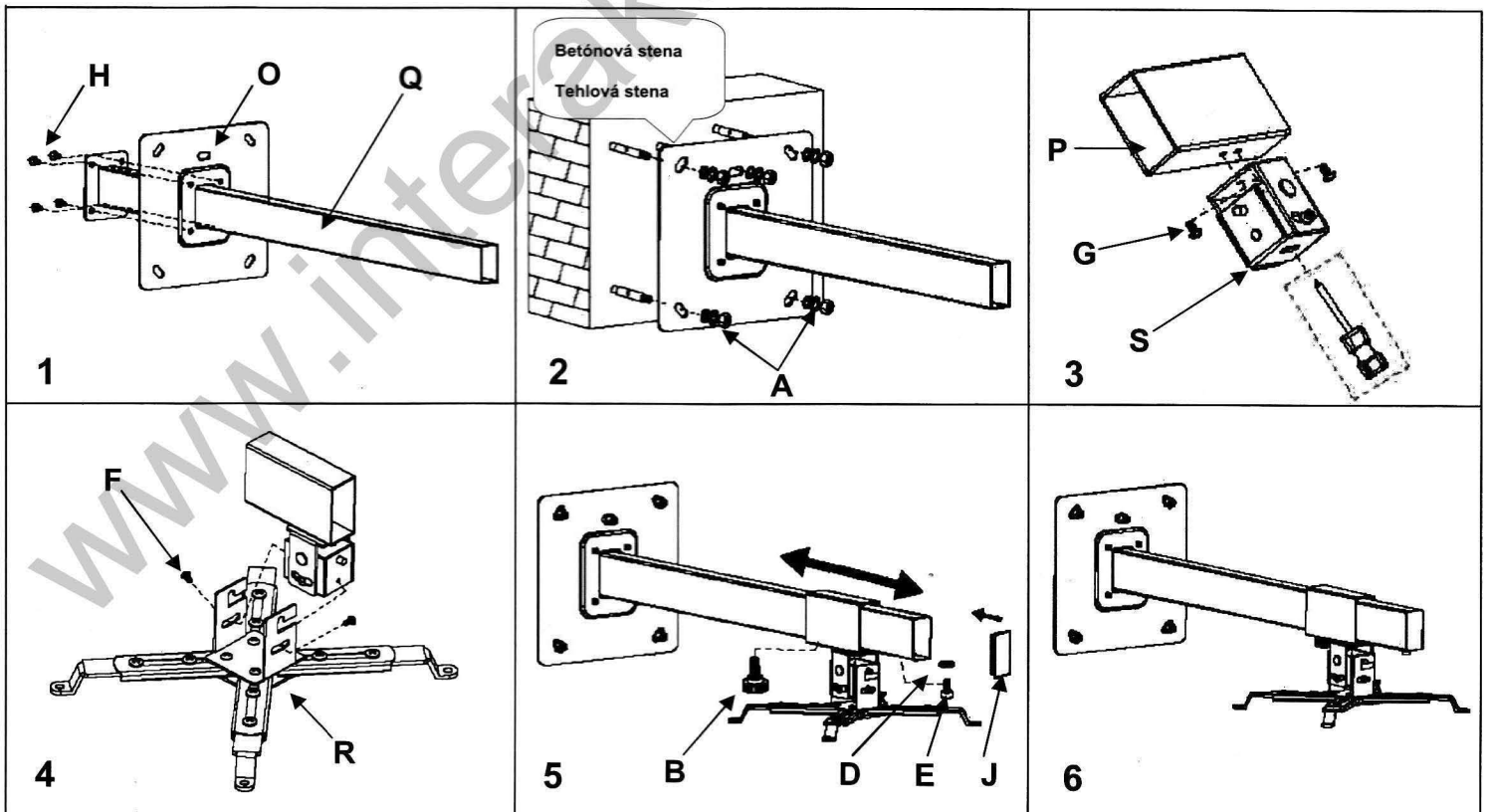

Pozn.: Pri montáži projektoru Acer S1283Hne odporúčame pre uľahčenie montáže vyskrutkovať gumené nožičky projektoru, prevliecť cez otvory (diel K) na ružici držiaku a znova zaskrutkovať. Nahradia tým pádom skrutky určené pre uchytenie samotného projektoru (diel L). Tieto 3 nožičky projektor bez problémov udržia váhu projektoru a zrýchlia samotnú montáž.